

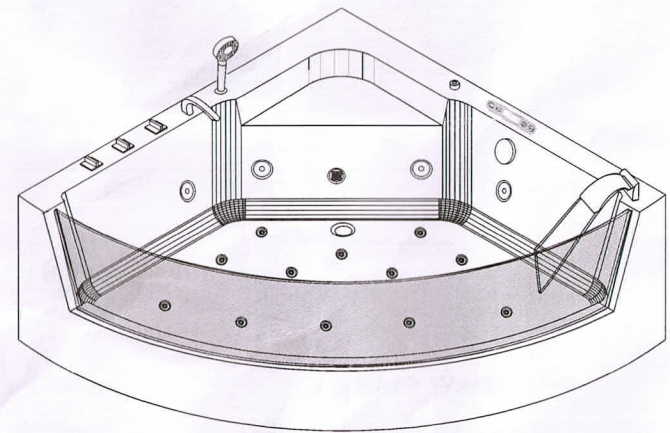

Cerutti

Luxury
massage bathtub



C-401

1500x1500x580 mm

Functional Introduction

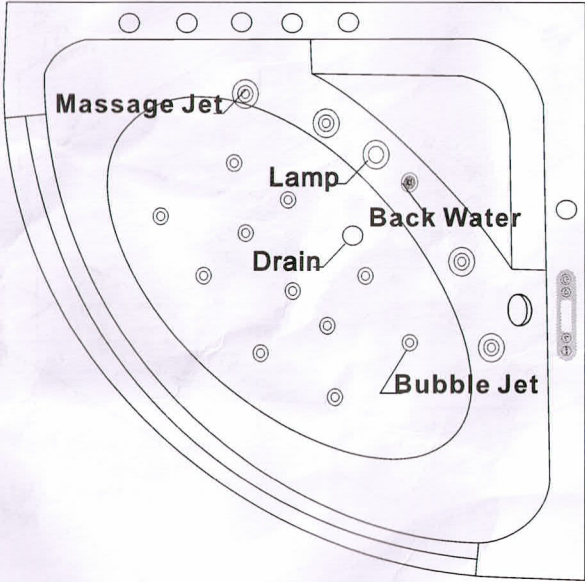
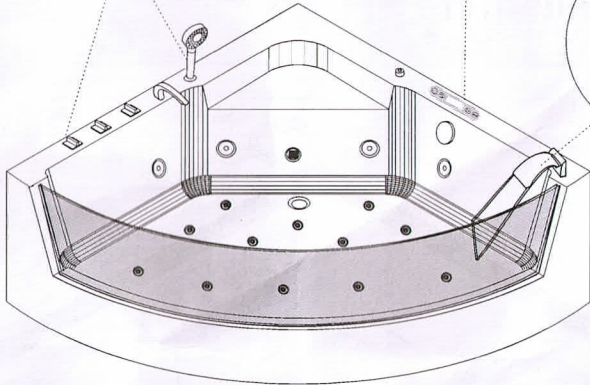
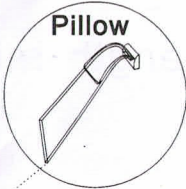
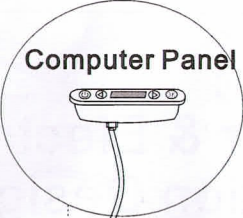

Water & Electricity Position Design

Length unit: mm

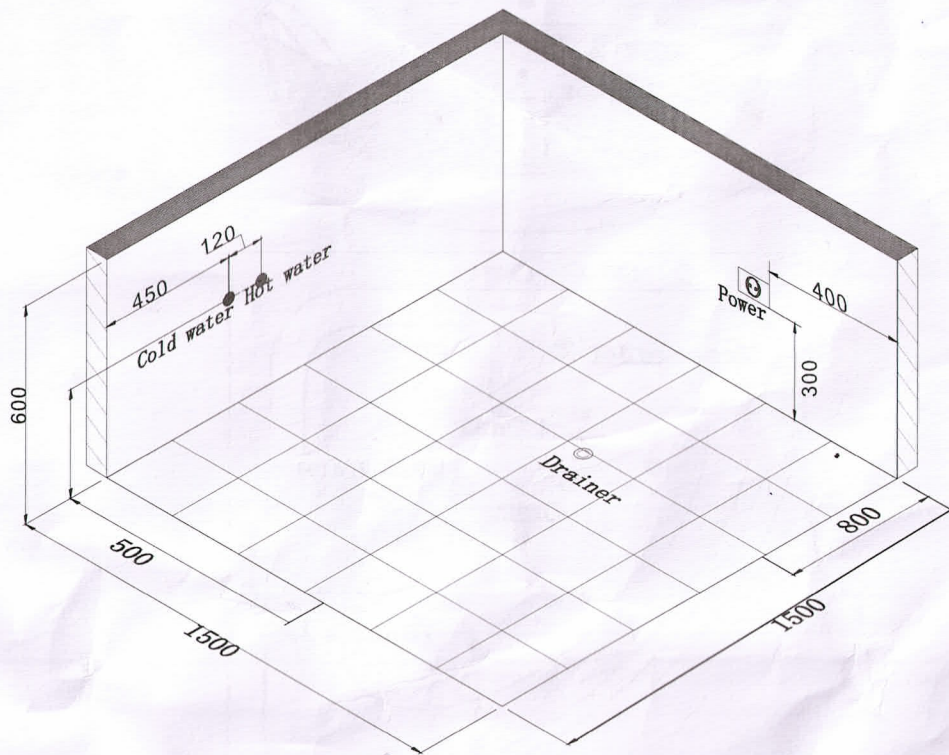

Accessories Installation

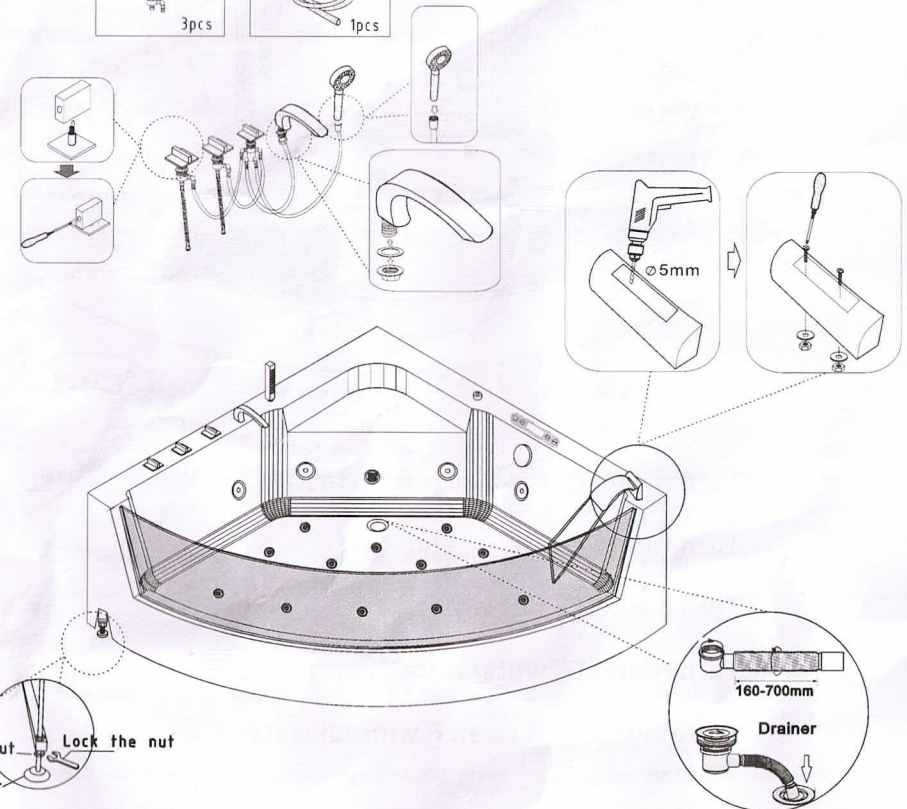
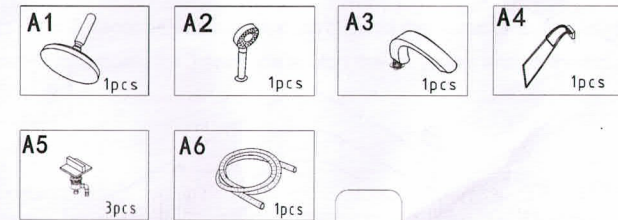
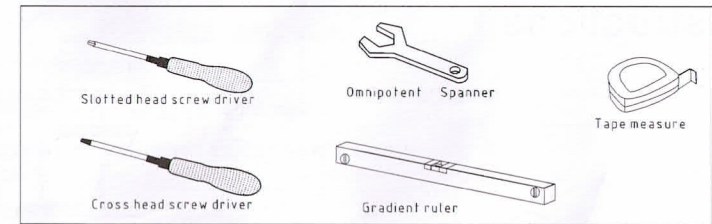

Functional Instructions

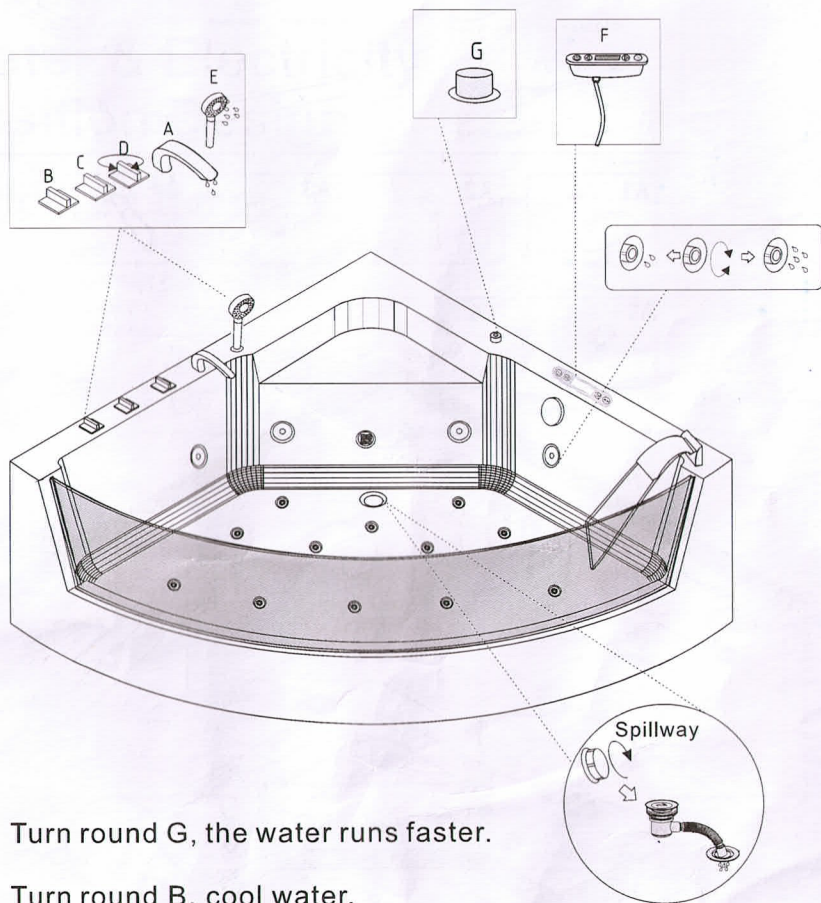

Turn round G, the water runs faster.

Turn round B, cool water.

Turn round C, hot water.

Turn round D, water comes from A or E.

Warning: do not open F without water!!

Operation of Computer Panel F

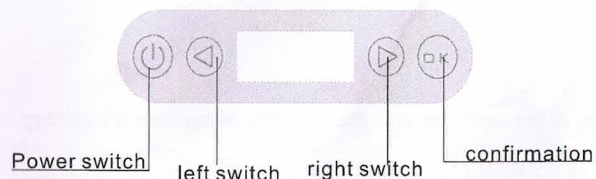

1. The buzzer will ring Di...when any button is pressed.

2. "power" power

Press "power" for 2 seconds to start the controller. At the same time, the lamp will be turned on ; press the icon again for 2 seconds to stop the controller and all the loads will be turned off.

3 Lamp

When the system is on, press "left", "right", till the cursor is on "lamp". Press "OK", lamp will turn on. Press "OK" again, lamp changes color. Press "OK", the lamp will turn off.

4. Lock

When the system is on, if there is no touch to the panel within 3 minutes, all the keys will be locked. And LCD will display "LOCK"; then press any key for 3 seconds, the keys will be unlocked. And the "LOCK" disappear from the LCD.

5. Ozone





5.1 When the system is on, continuously press "left", "right", when the cursor is on "ozone". Press "OK", ozone will be started. Symbol "ozone" will be dynamically displayed: Press "OK" again, ozone will be turned off and symbol "ozone" will be displayed statically.

6. Blower

When the system is on, press "left", "right", till cursor is on "blower". Press "OK", blower will be on. "blower" will be displayed dynamically; press "OK" again, the blower will be off. "blower" will be displayed statically.

7. Water pump surf

7.1 The water checking device of this controller protects the water pump from dry burning.

7.2 When the system is on, press " " " " till the cursor moved to " ", and then press " " to start the pump. If the water level sensor detects the water level have reached the set value then the pump will start to work. The pump icon will be displayed

dynamically. Press " " again to turn the pump off;

7.3 When the water level sensor sensed that the water level is lower than the set value, the pump can not be started.

7.4 When the water surf pump function is on, and the system checks the water level lower than the setting value, water surf pump function stops automatically, at the same time the pump icon blinks. Whenever the system checks the water level reaching the set value, the icon stops blink and the pump will resume to work.